

- Tüm ihtiyaçlarınıza yanıt verecek geniş ürün çeşitliliği
- Yüksek performans ve uzun kullanım ömrü
- İhtiyaçlarınıza uygun ölçülerde özel üretim avantajı
- Dürüst ve kaliteli hizmet

DØ 60-63	TİP 1	TİP 2	TİP 3
d Ø Mil	20	20 / 22	25
Rulman	6204	6204	6205
SW Anahtar Ağızı	14	14	18
t Boru Et Kalınlığı	3	3	3

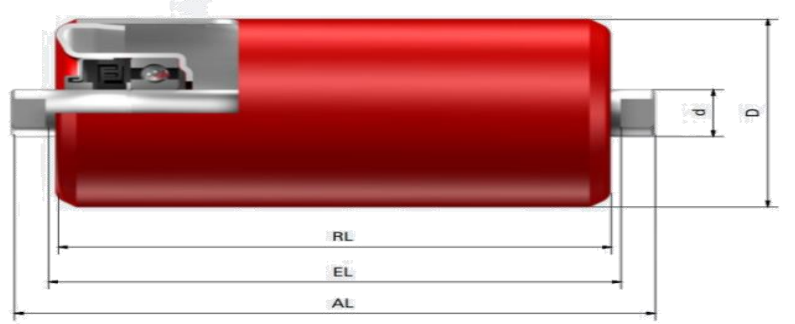

Norm: DIN 22212-2			BANT GENİŞLİĞİ			NORM: NFE 53300			BANT GENİŞLİĞİ		
RL	EL	AL				RL	EL	AL			
165	171	191	400	*	*	150	156	176	400	*	*
200	206	226	500	300	*	190	196	216	500	300	*
250	256	276	650	400	*	240	246	266	650	400	*
315	321	341	800	500	*	290	296	316	800	500	*
380	386	406/412	1000	650	300	360	366	386	1000	650	300
465	471	491	1200	800	*	430	436	456	1200	800	*
500	506	532	*	*	400	475	508	540	*	*	400
600	606	632	*	*	500	575	608	640	*	*	500
750	756	782	*	*	650	725	758	790	*	*	650
950	956	982	*	*	800	875	908	940	*	*	800
1150	1156	1182	*	*	1000	1115	1148	1190	*	*	1000
1400	1406	1432	*	*	1200	1315	1348	1380	*	*	1200





DØ 76	TİP 1	TİP 2	TİP 3
d Ø Mil	20	20 / 22	25
Rulman	6204	6204	6205
SW Anahtar Ağızı	14	14	18
t Boru Et Kalınlığı	3	3	3

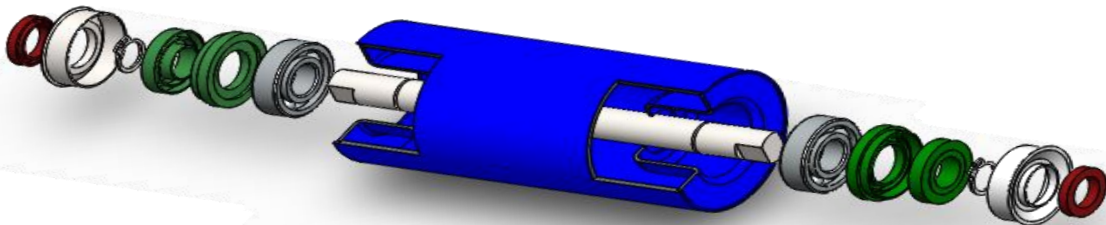

Norm: DIN 22212-2			BANT GENİŞLİĞİ			NORM: NFE 53300			BANT GENİŞLİĞİ		
RL	EL	AL				RL	EL	AL			
165	171	191	400	*	*	150	156	176	400	*	*
*	206	226	500	300	*	190	196	216	500	300	*
250	256	276	650	400	*	240	246	266	650	400	*
315	321	341	800	500	*	290	296	316	800	500	*
*	386	406/412	1000	650	300	360	366	386	1000	650	300
465	471	491	1200	800	*	430	436	456	1200	800	*
500	506	532	*	*	400	475	508	540	*	*	400
600	606	632	*	*	500	575	608	640	*	*	500
750	756	782	*	*	650	725	758	790	*	*	650
950	956	982	*	*	800	875	908	940	*	*	800
1150	1156	1182	*	*	1000	1115	1148	1190	*	*	1000
1400	1406	1432	*	*	1200	1315	1348	1380	*	*	1200

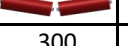





DØ 89	TİP 1	TİP 2	TİP 3	TİP 4	TİP 5	TİP 6
d Ø Mil	20	20 / 22	25	26	30	32/30
Rulman	6204	6204	6205	6305	6206	6306
SW Anahtar Ağzı	14	14	18	18	22	22
t Boru Et Kalınlığı	3mm	3mm	3mm	3mm	3mm	3mm

Norm: DIN 22212-2			BANT GENİŞLİĞİ			NORM: NFE 53300			BANT GENİŞLİĞİ		
RL	EL	AL				RL	EL	AL			
200	206	226	500	300	*	190	196	216	500	300	*
250	256	276	650	400	*	240	246	266	650	400	*
315	321	341	800	500	*	290	296	316	800	500	*
380	386	406/412	1000	650	300	360	366	386	1000	650	300
465	471	491	1200	800	*	430	436	456	1200	800	*
500	506	532	*	*	400	475	508	540	*	*	400
600	606	632	*	*	500	575	608	640	*	*	500
750	756	782	*	*	650	725	758	790	*	*	650
950	956	982	*	*	800	875	908	940	*	*	800
1150	1156	1182	*	*	1000	1115	1148	1190	*	*	1000
1400	1406	1432	*	*	1200	1315	1348	1380	*	*	1200
1600	1606	1632	*	*	1400	1515	1548	1580	*	*	1400

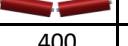



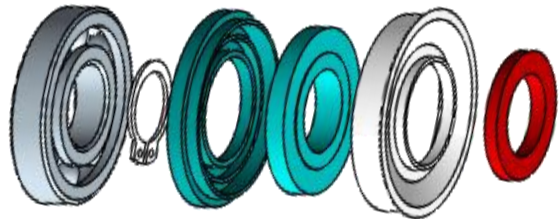

DØ 108	TİP 1	TİP 2	TİP 3	TİP 4	TİP 5	TİP 6	TİP 7
d Ø Mil	20	20 / 22	25	26	30	32/30	40
Rulman	6204	6204	6205	6305	6206	6306	6308
SW Anahtar Ağzı	14	14	18	18	22	22	32
t Boru Et Kalınlığı	3mm	3mm	3mm	3mm	3mm	3mm	4mm

Norm: DIN 22212-2			BANT GENİŞLİĞİ			NORM: NFE 53300			BANT GENİŞLİĞİ		
RL	EL	AL				RL	EL	AL			
250	256	276	650	400	*	240	246	266	650	400	*
315	321	341	800	500	*	290	296	316	800	500	*
380	386	406/412	1000	650	300	360	366	386	1000	650	300
465	471	491	1200	800	*	430	436	456	1200	800	*
500	506	532	*	*	400	475	508	540	*	*	400
600	606	632	*	*	500	500	506	526	1400	*	*
750	756	782	*	*	650	570	576	596	1600	1000	*
950	956	982	*	*	800	575	608	640	*	*	500
1150	1156	1182	*	*	1000	725	758	790	*	*	650
1400	1406	1432	*	*	1200	875	908	940	*	*	800
1600	1606	1632	*	*	1400	1115	1148	1190	*	*	1000
1800	1806	1832	*	*	1600	1315	1348	1380	*	*	1200
						1515	1548	1580	*	*	1400
						1715	1748	1780	*	*	1600

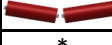





DØ 133	TİP 1	TİP 2	TİP 3	TİP 4	TİP 5	TİP 6	TİP 7
d Ø Mil	20	20 / 22	25	26	30	32/30	40
Rulman	6204	6204	6205	6305	6206	6306	6308
SW Anahtar Ağızı	14	14	18	18	22	22	32
t Boru Et Kalınlığı	4mm	4mm	4mm	4mm	4mm	4mm	4mm

Norm: DIN 22212-2			BANT GENİŞLİĞİ			NORM: NFE 53300			BANT GENİŞLİĞİ		
RL	EL	AL				RL	EL	AL			
315	321	341	800	*	*	290	296	315	800	*	*
380	386	406	1000	650	*	355	366	386	1000	650	*
465	471	491	1200	800	*	425	436	456	1200	800	*
530	536	556	1400	*	*	495	506	526	1400	*	*
600	606	626/632	1600	1000	*	565	576	596	1600	1000	*
670	676	696	1800	*	*	635	646	666	1800	*	*
700	706	726	*	1200	*	575	608	640	*	*	500
750	756	776/782	2000	*	650	725	758	790	2000	*	650
800	806	832	2200	1400	*	875	908	940	*	*	800
900	906	932	2400	1600	*	1115	1148	1180	*	*	1000
950	956	982	2600	*	800	1315	1348	1380	*	*	1200
1150	1156	1182	*	2000	1000	1515	1548	1580	*	*	1400
1400	1406	1432	*	*	1200	1715	1748	1780	*	*	1600
1600	1606	1632	*	*	1400						
1800	1806	1832	*	2400	1600						

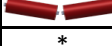

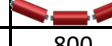
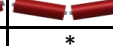
DØ 159	TİP 1	TİP 2	TİP 3	TİP 4	TİP 5	TİP 6	TİP 7
d Ø Mil	20	20 / 22	25	26/25	30	32/30	40
Rulman	6204	6204	6205	6305	6206	6306	6308
SW Anahtar Ağızı	14	14	18	18	22	22	32
t Boru Et Kalınlığı	4mm	4mm	4mm	4mm	4mm	5mm	5mm

Norm: DIN 22212-2			BANT GENİŞLİĞİ			NORM: NFE 53300			BANT GENİŞLİĞİ		
RL	EL	AL				RL	EL	AL			
315	321	341	800	*	*	290	296	315	800	*	*
380	386	406	1000	650	*	355	366	386	1000	650	*
465	471	491	1200	800	*	425	436	456	1200	800	*
530	536	556	1400	*	*	495	506	526	1400	*	*
600	606	626/632	1600	1000	*	565	576	596	1600	1000	*
670	676	696	1800	*	*	635	646	666	1800	*	*
700	706	726	*	1200	*	575	608	640	*	*	500
750	756	776/782	2000	*	650	725	758	790	2000	*	650
800	806	832	2200	1400	*	875	908	940	*	*	800
900	906	932	2400	1600	*	1115	1148	1180	*	*	1000
950	956	982	2600	*	800	1315	1348	1380	*	*	1200
1150	1156	1182	*	2000	1000	1515	1548	1580	*	*	1400
1400	1406	1432	*	*	1200	1715	1748	1780	*	*	1600
1600	1606	1632	*	*	1400						
1800	1806	1832	*	2400	1600						
2000	2006	2032	*	*	1800						
2200	2206	2232	*	*	2000						

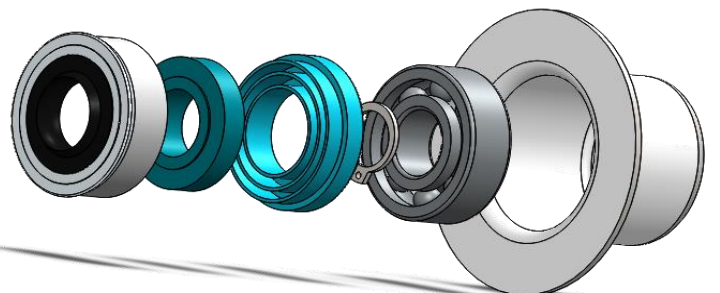

	DØ 60-63	DØ 76	DØ 89	DØ 108	DØ 133	DØ 159
Kalite Standartı	DIN 22212-2- NFE 53300					
Rulman	6204-6205 isteğe göre ZZ-2RS					
Boru	DIN 2458 EN 10219 St-37-2 kalite					
Boru Et Kalınlığı	3mm - 4mm			4mm - 5mm		
Mil Çapı	Ø20 mm – Ø25 mm					
Mil Özelliği	Ç1050-Ç1040-Ç1018 Soğuk Çekme					
Rulman Yatağı	Ereğli A1 kalite					
Boya	Elektrostatik 60-70 mikron fırın boya					
İmalat Özellikleri	Toz ve Su geçirmez 4 lü labirent sistemi					
	Otomatik çevresel kaynak					
	Ral 2000 yaş boya ve Galveniz kaplama					

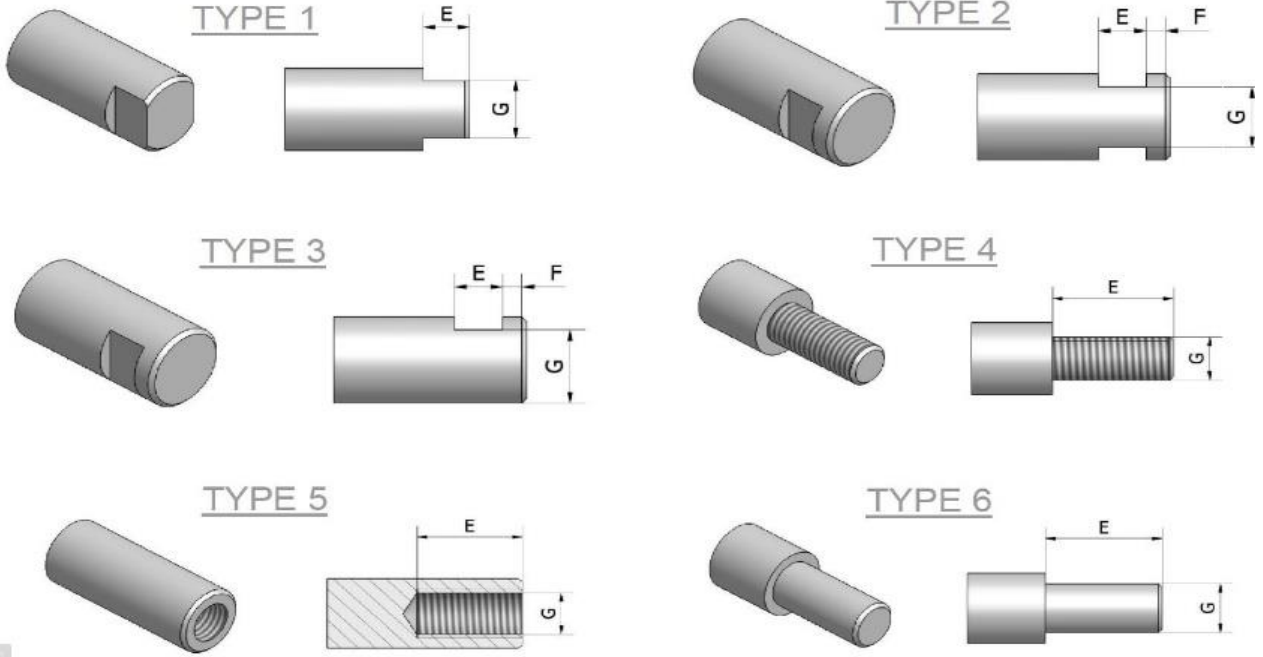

- Tüm ihtiyaçlarınıza yanıt verecek geniş ürün çeşitliliği
- Yüksek performans ve uzun kullanım ömrü
- İhtiyaçlarınıza uygun ölçülerde özel üretim avantajı
- Dürüst ve kaliteli hizmet

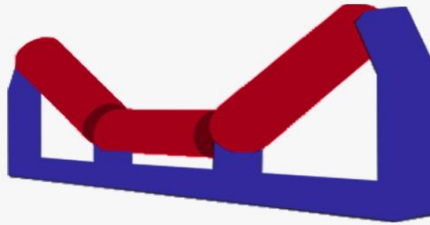

# KIRTAŞ